

8 7 6 5 4 3 2 1

D
C
B
A

D
C
B
A

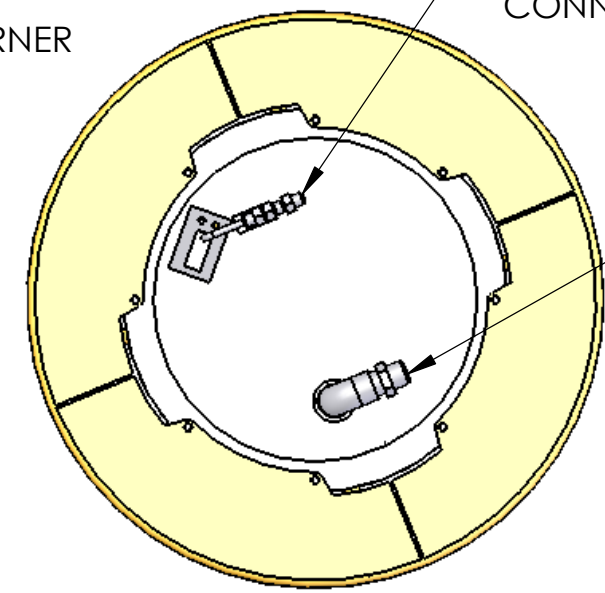
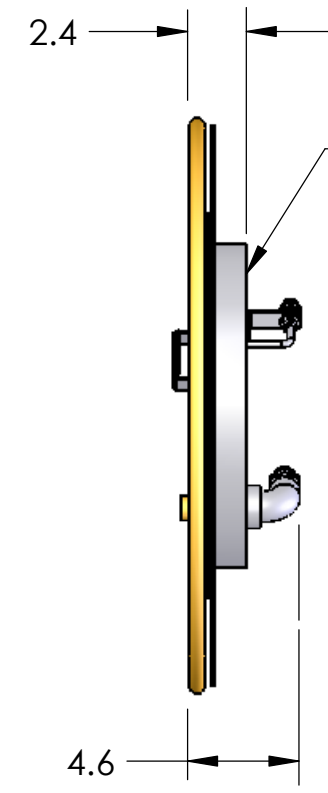
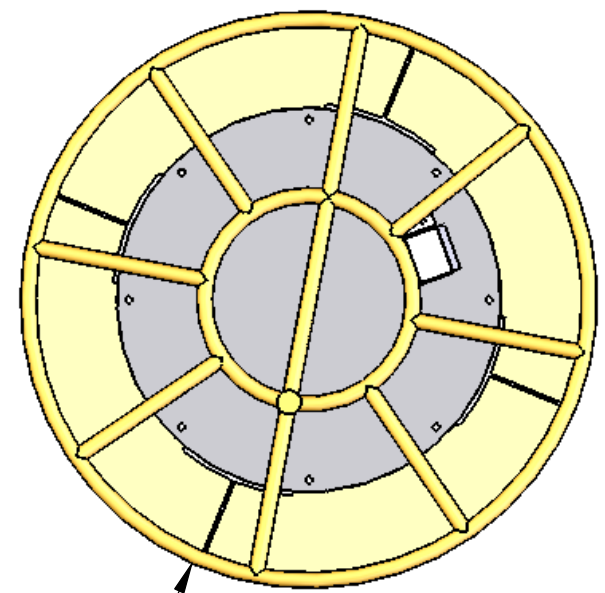
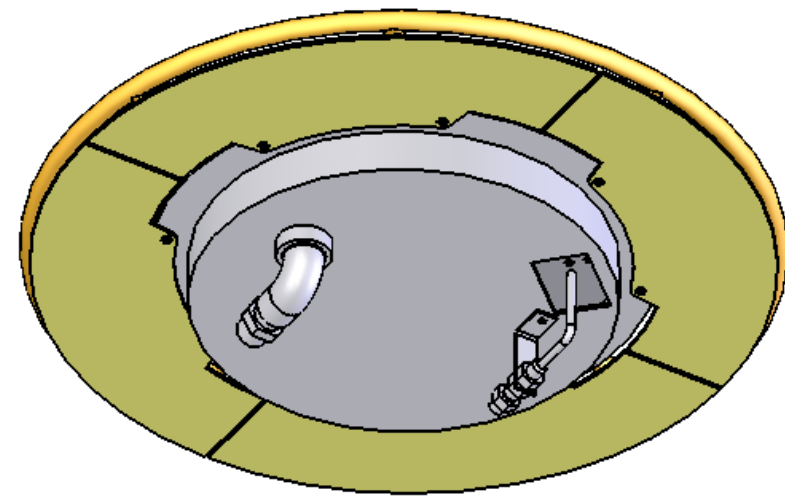
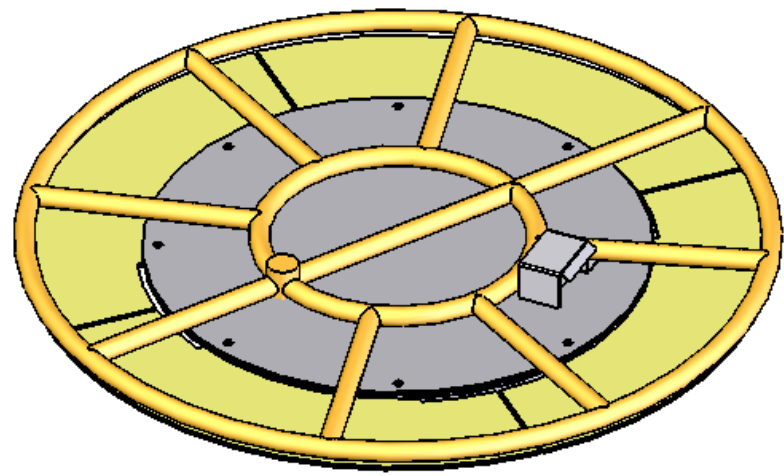

24" DIAMETER BURNER

INSULATED BURNER HOUSING

PILOT CONNECTOR

MAIN GAS CONNECTOR

PROPRIETARY AND CONFIDENTIAL
THE INFORMATION CONTAINED IN THIS DRAWING IS THE SOLE PROPERTY OF GRAND EFFECTS, INC.. ANY REPRODUCTION IN PART OR AS A WHOLE WITHOUT THE WRITTEN PERMISSION OF GRAND EFFECTS, INC. IS PROHIBITED.

		UNLESS OTHERWISE SPECIFIED:		NAME	DATE	GRAND EFFECTS, INC. MISSION VIEJO, CA	
		DIMENSIONS ARE IN INCHES		DRAWN	DRR	4-19-15	TITLE: BURNER ASSY. - 24"
		TOLERANCES:		CHECKED			
		FRACTIONAL ±1/32		ENG APPR.			
		ANGULAR: MACH ±1° BEND ±1°		MFG APPR.			
		TWO PLACE DECIMAL ±.03		Q.A.			SIZE
		THREE PLACE DECIMAL ±.010		COMMENTS:			DWG. NO.
		INTERPRET GEOMETRIC TOLERANCING PER:ANSI Y14.5M-1994					REV
		MATERIAL					B
NEXT ASSY	USED ON	FINISH					BA-24
APPLICATION		DO NOT SCALE DRAWING					-
							SCALE: 1:1
							WEIGHT:
							SHEET 1 OF 1

8 7 6 5 4 3 2 1